User Manual

Manually operated sliding door

Manually operated sliding door

User manual for manually operated Sky-Frame sliding doors.



Sky-Frame Inc.

5912 Blackwelder St
Culver City, CA 90232
USA

Telephone: +1 (424) 298-8906
E-Mail: info@sky-frame.com
Website: www.sky-frame.com

Headquarters:

Sky-Frame AG

Langfeldstrasse 111
CH-8500 Frauenfeld
Switzerland

Phone: +41 52 724 94 94
E-mail: info@sky-frame.com
Internet: www.sky-frame.com

User Manual

Manually operated sliding doors Table of contents

Table of contents			
	1	General information	14.1.1.1
	1.1	Information concerning this manual	14.1.1.1
	1.2	Explanation of symbols	14.1.1.1
	1.3	Liability restriction	14.1.1.2
	1.4	Copyright	14.1.1.3
	1.5	Warranty conditions	14.1.1.3
	1.6	Customer service	14.1.1.3
	2	Safety	14.1.2.1
	2.1	Use for correct purpose	14.1.2.1
	2.2	Basic dangers	14.1.2.2
	3	Technical data	14.1.3.1
	3.1	General information	14.1.3.1
	3.2	Operating conditions	14.1.3.1
	4	Design and functionality	14.1.4.1
	4.1	Short description	14.1.4.1
	4.2	Types of casement doors	14.1.4.1
	5	Operation	14.1.5.1
	5.1	Operating safety instructions	14.1.5.1
	5.2	Opening/closing the casement doors	14.1.5.3
	5.2.1	Single-panel casement door + extension	14.1.5.3
	5.2.2	Opening / closing a combined system	14.1.5.5
	6	Cleaning and care	14.1.6.1
	7	Trouble-shooting	14.1.7.1
	7.1	Debugging the system	14.1.7.1
	7.2	Glass properties	14.1.7.2
	8	Dismantling and disposal	14.1.8.1

User Manual

Manually operated sliding doors General information

1. General information 1.1 Information concerning this manual

This manual describes how to use the system safely and efficiently. The manual is a constituent of the system and must be accessible and in close proximity to the system at all times.

Always read manual carefully before starting work. A basic prerequisite for safe working is adhering to all safety instructions and action instructions in this manual.

The illustrations in this manual are intended to provide a basic understanding and may differ from the actual situation.

1.2 Explanation of symbols

Safety instructions:

The safety instructions in this manual are marked with symbols. The safety instructions are preceded by signal words that indicate the level of danger. Adhering to the safety instructions and taking careful action will help to avoid accidents, injuries and damage to property.

⚠ WARNING



Indicates a hazardous situation which, if not avoided, could result in death or serious injury.

⚠ CAUTION



Indicates a hazardous situation which, if not avoided, could result in minor or moderate injury.

NOTICE



Addresses practices not related to personal injury. Also highlights useful tips, recommendations and information for efficient and fault-free operation.

User Manual

Manually operated sliding doors General information

Safety symbols in this manual

A safety symbol is used to explain a safety instruction. In this manual the following safety symbols are used:



Risk of injuries due to squeezing

Other symbols in this manual

The following symbols and highlighting are used in this manual to mark action instructions, result descriptions, lists, references and other elements:

1. Marks step-by-step action instructions.

-> Marks a status or an automatic sequence resulting from an action step.

- Marks lists and list entries with no fixed order.

[-> Page No.] References to chapters in this manual.

1.3 Liability restriction

All information and notes in this manual have been put together taking the applicable standards and regulations, the state of technology, our knowledge and our many years of experience into consideration.

The manufacturer does not accept liability for damage caused by:

- Failure to follow the instructions in the manual
- Failure to use the equipment for its correct purpose
- Making technical modifications
- Using non-approved spare parts

The actual scope of delivery may differ from the information in this manual in the event of customised versions, the use of additional ordering options or because of technical changes.

The obligations agreed in the delivery agreement, the manufacturer his general business terms and conditions and delivery conditions, and the legal regulations that were applicable when the agreement was signed are applicable.

User Manual

Manually operated sliding doors General information

1.4 Copyright

This manual is protected by copyright.

Passing this manual to third parties, any form of duplication (including extracts of the manual) and the use and/or disclosure of the content are not permitted without the manufacturer's written permission.

1.5 Warranty conditions

The warranty conditions are included in the manufacturer's general business terms and conditions.

1.6 Customer service

If you have questions about your Sky-Frame product please contact your official Sky-Frame partner (see last page).

Our employees are also always interested in receiving new information and experiences resulting from the use of the equipment that may be useful for improving our products.

User Manual

Manually operated sliding doors Safety

2. Safety

This section provides an overview of all important safety aspects for providing the user with the best possible protection and for ensuring that operation is safe and problem-free.

Failure to observe the action instructions and safety instructions in this manual can lead to considerable danger.

2.1 Use for correct purpose

The equipment is exclusively designed and constructed for the intended purpose of use that is described in this document.

The equipment is exclusively intended for installation in a wall opening, and is intended to provide light, ventilation and access.

Correct purpose of use also includes complying with all of the specifications in this manual.

Any other use is considered to be incorrect.

⚠ WARNING

Incorrect use can lead to dangerous situations!

- The sliding panels must never be bent, twisted or subjected to additional loads.
- Do not place objects in the door area between the sliding panels and the frame.
- If any objects get in this area unintentionally, remove them before sliding the doors.
- Never slacken screws or remove them from the system.



Claims of any kind for damage caused by incorrect use will not be entertained.

User Manual

Manually operated sliding doors Safety

2.2 Basic dangers

In order to minimise health hazards and avoid dangerous situations, the safety instructions listed here and in the other chapters of this manual must be followed.

Transparent wall connection



▲WARNING

Risk of injury from transparent wall connection!

- In case of doubt, check that the casement door is open.
- An authorised person must point out the danger to unauthorised persons or persons (including children) who are at risk because of their physical, sensory or mental capabilities or due to lack of experience or awareness.

Objects in the immediate vicinity of the door

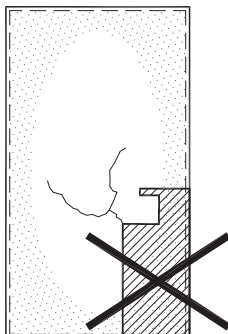

▲WARNING

Risk of injury and/or glass breakage* from selective heating of the glass due to objects in the immediate vicinity of the glass!

- Do not place objects in the immediate proximity (30 cm) of the sliding door!

* Only possible when glass configuration differs from standard (TSG-H = tempered safety glass with heat soak test).

User Manual

Manually operated sliding doors Technical data

Moving components

⚠ CAUTION

Risk of squeezing from moving components when opening and closing the casement door!

- Before opening and closing the casement door, ensure that no persons are present in the door area.

- **Do not reach into or handle moving components whilst the door is being opened and closed.**

- Persons (including children) who are incapable of using the equipment safely because of their physical, sensory or mental capabilities or lack of experience or awareness may not use the equipment without supervision or instruction from a responsible person.

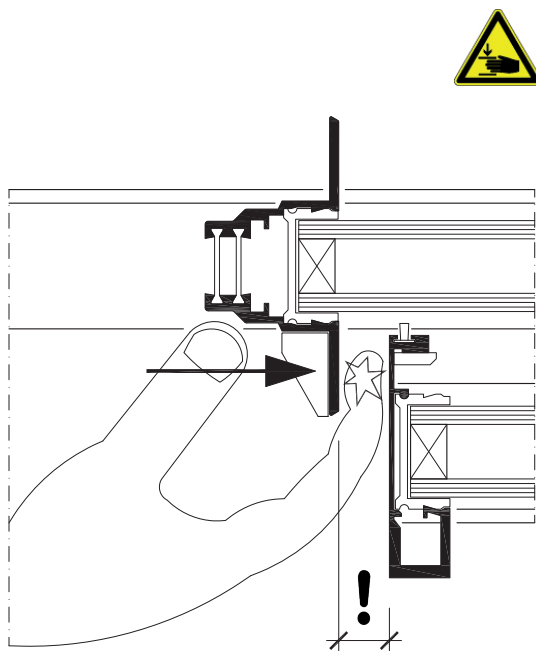

3. Technical data 3.1 General information

The technical data (dimensions, weights etc.) can be found in the layout plans (delivery drawings) and data sheets.

3.2 Operating conditions

Temperature range -20°C to +40°C

Humidity non-condensing

User Manual

Manually operated sliding doors Design and functionality

4. Design and functionality 4.1 Short description

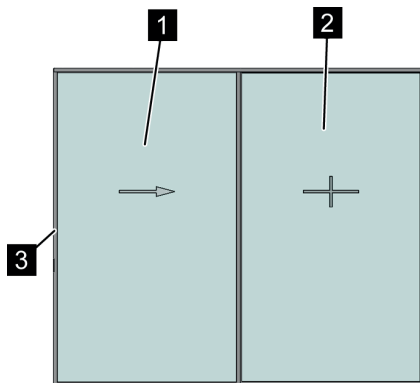

Fig. 1: Single-panel casement door

The single casement door consists of a fixed panel (2) and a sliding panel (1).

The sliding panel (1) is opened (arrow) and closed by operating a locking handle (3).

The sliding panel is locked when it is closed and unlocked by the locking handle (3) when it is opened.

- 1 Sliding panel
- 2 Fixed panel
- 3 Locking/opening profile with locking handle

4.2 Types of casement door

The following types of opening are available:

- Single-panel casement door [->Page 14.1.4.2]
- Extending casement door [->Page 14.1.4.2]
- Combined system [->Page 14.1.4.3]
- Wallside opening
- Centre opening
- Centre opening on same level
- Corner opening

User Manual

Manually operated sliding doors Design and functionality

Single-panel casement door

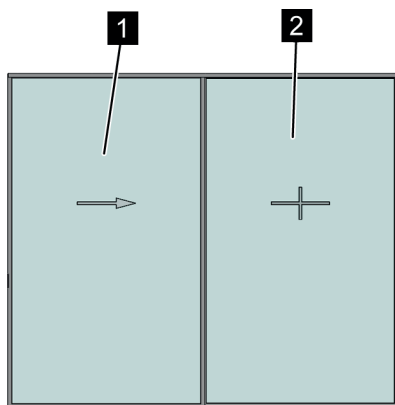

Fig. 2: Single-panel casement door

Only the sliding panel (1) of the single-panel casement door moves.

The arrow (Fig. 2) indicates the opening direction.

- 1 Sliding panel
- 2 Fixed panel

Extending casement door

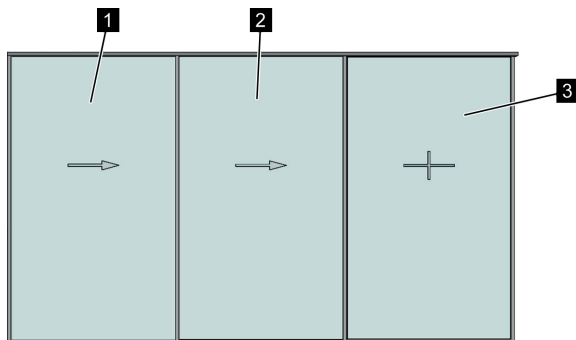

Fig. 3: Right extension

The extending casement door has two extension panels (1) and (2).

When the door opens (arrows) both extension panels move together until the extension panel (2) reaches the end position in the fixed panel (3).

The sliding panel (1) continues to open until it comes up against the locking profile of the sliding panel (2).

When the door closes, the two extension panels (1) and (2) move together until the extension panel (2) engages in the fixed panel (3).

The extending panel (1) continues to move until it engages in the end position. The system is locked in this position.

- 1 Extension panel 1
- 2 Extension panel 2
- 3 Fixed panel

User Manual

Manually operated sliding doors Design and functionality

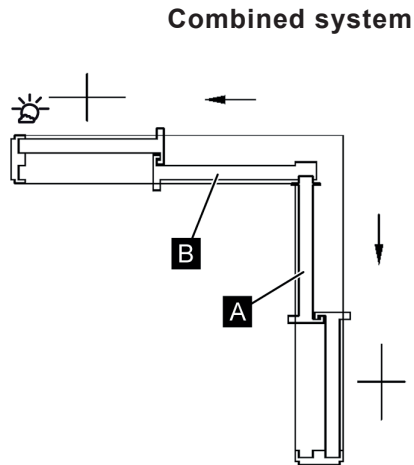

The single-panel casement door (Fig. 2) and the extension (Fig. 3) can be combined in different variants to create a system (Fig. 4 and Fig. 5).

A combined system is divided up into system **A** and system **B**.

System **A** is a system that opens first and closes last.

System **B** is a system that opens second and closes first. The arrows (Fig. 4 and Fig. 5) show the opening direction of the systems.

The symbol ☀ indicates the outside of the system.

Fig. 4: Combined system, top-down view

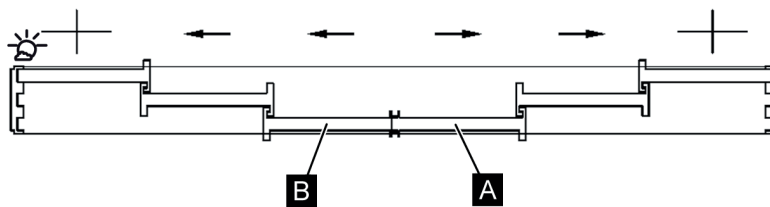

Fig. 5: Combined extending system, top-down view (left extension and right extension)

A combined double extending system (Fig. 5) consists of four sliding panels.

Two of the sliding panels are opened to the right (system **A**) and the other two open to the left (system **B**).

User Manual

Manually operated sliding doors Operation

5. Operation 5.1 Operating safety instructions

The system has been manufactured taking the applicable standards and regulations, the state of technology, our knowledge and our many years of experience into consideration.

However, injuries can still occur in the event of improper behaviour. Please observe the safety instructions explained in the following to avoid dangerous situations.

Incorrect operation



⚠ WARNING

Risk of injury/ damage of property due to incorrect operation!

- The sliding panels must never be bent, twisted or subjected to additional loads.
- Do not place objects in the door area between the sliding panels and the frame.
- Never slacken screws or remove them from the system.
- During operation the whole area of movement must be visible for the operator and free of any objects/ persons.

Moving components



⚠ CAUTION

Risk of squeezing from moving components when opening and closing the casement door!

Moving components can cause injuries when opening and closing the casement door.

- Before opening and closing the casement door, ensure that no persons or objects are present in the door area.
- Do not reach into or handle moving components whilst the door is being opened and closed.
- Persons (including children) who are incapable of using the equipment safely because of their physical, sensory or mental capabilities or lack of experience or awareness may not use the equipment without supervision or instruction from a responsible person.

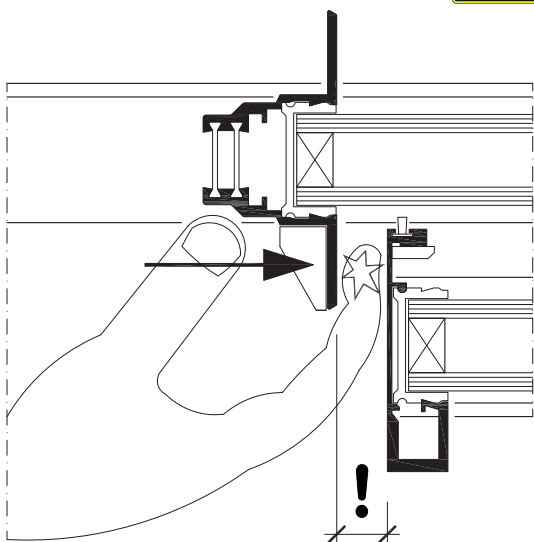

User Manual

Manually operated sliding doors Operation

Danger areas

The marked dots in the illustration (Fig. 6) show the possible danger areas on the system, where persons are at risk of injury in the event of improper behaviour.

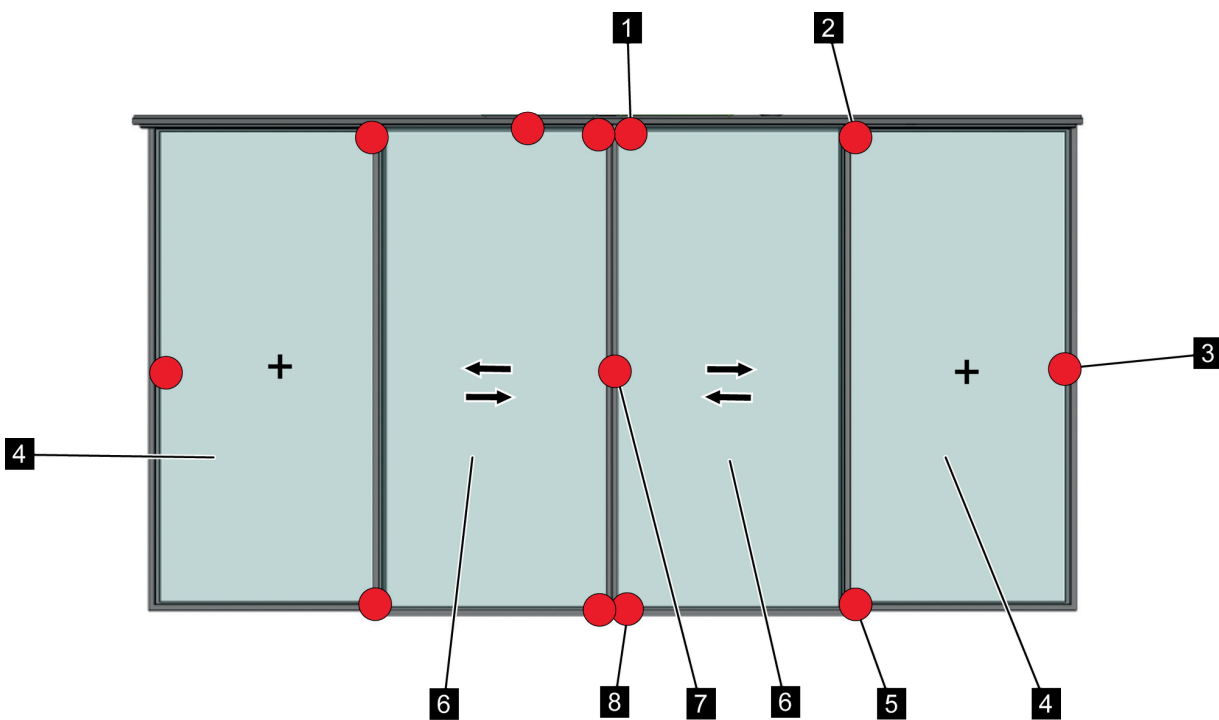

- Fig. 6: Danger areas*
- 1 Between top edge of panel and runner when closing
 - 2 Between top edge of panel and runner when opening
 - 3 Between sliding panels and between sliding panel and frame when opening
 - 4 Fixed panel
 - 5 Between bottom edge of panel and runner when opening
 - 6 Sliding panel
 - 7 Between sliding panels and between sliding panel and frame when closing
 - 8 Between bottom edge of panel and runner when closing

User Manual

Manually operated sliding doors Operation

5.2 Opening/closing the casement doors

5.2.1 Single-panel casement door and extension

Opening the casement door

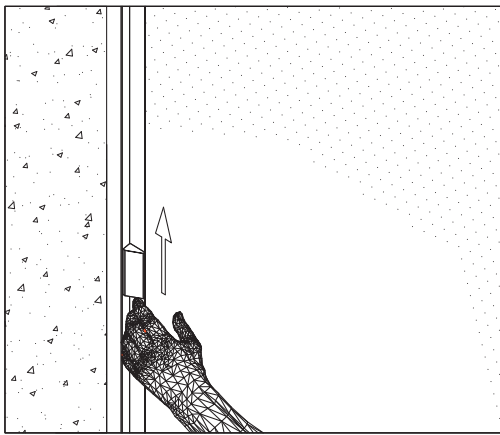

Fig. 7: Unlocking the locking handle

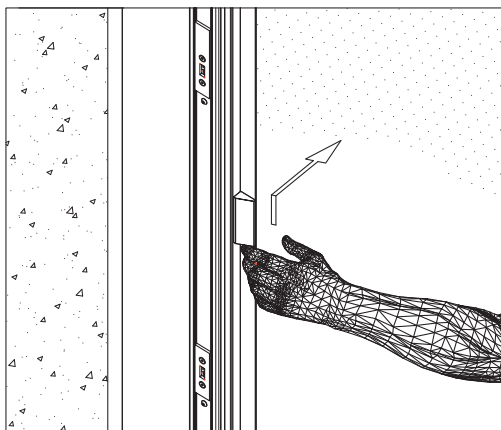

Fig. 8: Opening the casement door

The method of operation of the single-panel casement door and the casement door extension is identical.

1. Slide locking handle upwards (arrow) and hold in this position.

-> The casement door is unlocked.

2. Ensure that no living beings or objects are in the door area.

CAUTION

Risk of squeezing/ property damage from uncontrolled opening and closing of the sliding panels!

- Move sliding panels slowly when opening and closing.
 - Ensure that the sliding panel is moved along the frame extremely slowly, and that it does not bump against it in an uncontrolled way when it reaches the end position.
 - Ensure that no persons/ fingers/ objects are in the space between two sliding panels respectively between sliding panel and frame.
3. Open sliding panel slowly (arrow).

User Manual

Manually operated sliding doors Operation

Closing the casement door

1. Ensure that no living beings or objects are in the door area.

⚠ CAUTION

Risk of squeezing/ property damage from uncontrolled opening and closing of the sliding panels!



- Move sliding panels slowly when opening and closing.
- Ensure that the sliding panel is moved along the frame extremely slowly, and that it does not bump against it in an uncontrolled way when it reaches the end position.
- Ensure that no persons/ fingers/ objects are in the space between two sliding panels respectively between sliding panel and frame.

2. Slowly move the sliding panel as far as it will go.

-> The casement door is locked automatically.

NOTICE

Risk of being locked out!



Casement doors that do not have a locking handle on the outside lock automatically when they are fully closed (otherwise you'll need a locking handle with locking catch).

User Manual

Manually operated sliding doors Operation

Casement door with locking catch

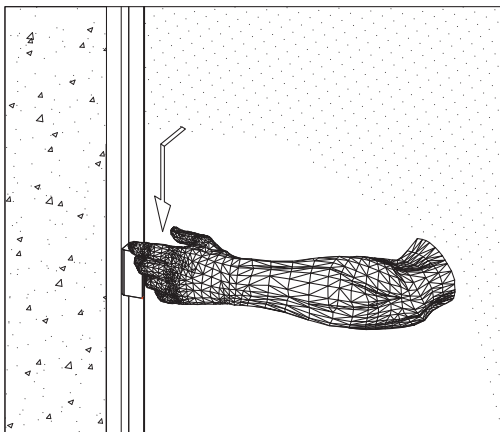

Fig. 9: Locking the casement door

If you want to be able to fully close the casement door from the outside without it locking automatically, a locking handle with locking catch must be used.

The locking catch holds up the locking handle so that the panel is not locked.

In order to lock the casement doors again after opening, the locking handle with locking catch must be pushed down manually.

1. Push locking handle down (arrow).

5.2.2 Opening/closing a combined system

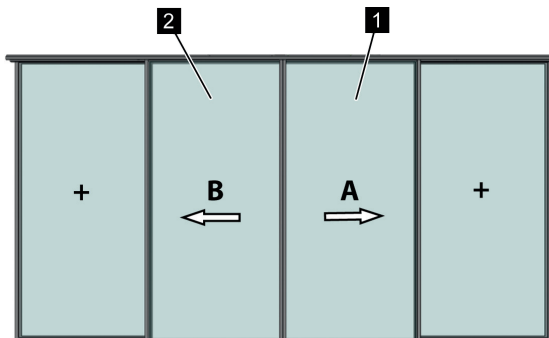

Fig. 10: Two-panel system

Opening the system:

1. Unlock sliding panel (1) of system **A** and open (arrow). [-> «Opening the casement door» on page 14.1.5.3].
2. Open sliding panel (2) of system **B**.

Closing the system:

1. Close sliding panel (2) of system **B**.
2. Close sliding panel (1) of system **A**. [-> «Closing the casement door» on page 14.1.5.4].

NOTICE

Risk of being locked out!

Casement doors that do not have a locking handle on the outside lock automatically when they are fully closed (otherwise you'll need the "non self locking" handles).



User Manual

Manually operated sliding doors Cleaning and care

6. Cleaning and care



1. Clean panes of glass with a soft cloth and a normal commercial glass cleaner. Use ladder with stable stand.
2. Remove soiling from base profile with a vacuum cleaner.
3. Clean base profile with a damp cloth and a liquid cleaning agent.
4. Check the gutter for soiling and clean if necessary.
5. Ensure that the water can flow away in the gutter.
6. Remove all tools, materials and other equipment from the working area.
7. Clean working area and remove any materials such as liquids, consumables or the like that may be present.

⚠ CAUTION

Improper cleaning can cause damage!

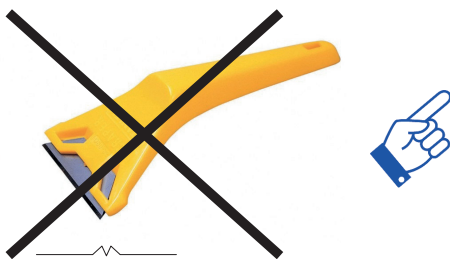

- **Never use metal blades / glass scrapers** to clean the glass, even if this is recommended.
- The driving rail may be cleaned with a vacuum cleaner.
- Do not use abrasive or scouring material.
- Never use cleaning agents containing solvent or scouring material, clean with soapy water and a coat.
- Do not use alkalis (lyes).
- Grains of dirt caught in the cleaning cloth can scratch the glass.
- The use of a pressure washer is not suitable for cleaning.

User Manual

Manually operated sliding doors Cleaning and care

Seals

The seals have been treated with silicone in the factory to prevent them from freezing on.



If this protection has deteriorated over time, proceed as follows:

1. Spray silicone spray onto a cloth outdoors.
2. Apply silicone spray to the seals using the cloth.

NOTICE

Damage caused by road salt!

Road salt can damage the casement doors. Avoid use of road salt in the immediate vicinity of the casement door.



Insect screen

Clean frame, handle profile and fabric with soapy water and a soft cloth.

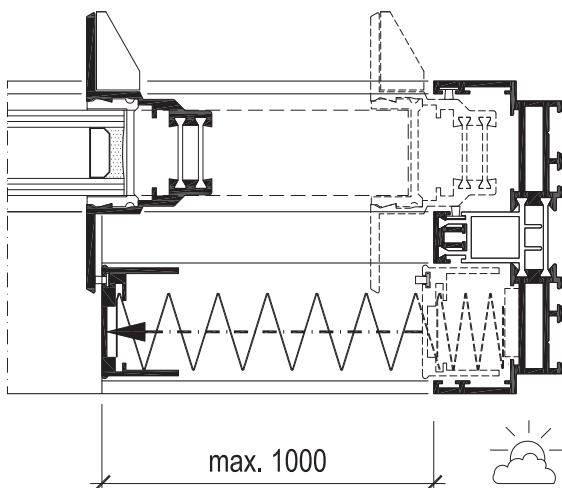

TIP:

The fabric can also be cleaned by blowing through it from the inside to the outside using compressed air or a hair dryer (using cold air).

▲ CAUTION

- NEVER use chemical or abrasive materials!
- In strong winds, the insect screens must be closed immediately (risk of damage).

User Manual

Manually operated sliding doors Trouble-shooting

7. Trouble-shooting

The possible causes of faults and the work that is required to remedy them are described in the following chapter. Please contact specialist company in the event of faults that cannot be remedied using the following instructions. See on last page for contact information.

7.1 Debugging the system

Sliding panel cannot be moved:

- Object trapped between sliding panel and frame
-> remove object
- Damage to system -> contact a specialist company

Sliding panel can only be moved slowly:

- Heavy soiling in movement area
-> clean system

Incorrect repair

⚠ WARNING

Risk of injury from incorrect repair!

- Only skilled personnel may repair the system.
- Never dismantle the system.
- Never repair or modify the system yourself.
- In case of system malfunction call a service technician.



Spare parts

⚠ WARNING

Risk of injury from using the wrong spare parts!

- Only use original spare parts
- Always have defective parts replaced by a specialist company.



User Manual

Manually operated sliding doors Trouble-shooting

External condensation



The external glass is in a direct "radiation exchange" with the sky. Depending on the installation situation, this radiation exchange can now lead to considerable cooling of the external glass (particularly on clear nights).

If the temperature of the outer glass surface drops below the temperature of the adjacent outside air, this will result in the formation of condensation on the outer surface of the glass (even ice in certain cases).

This procedure is generally known in nature as dew or hoar frost formation.

Heating of the outer surface and the outside air (by the morning sun, for example) will cause the condensation to disappear again.

This phenomenon is not a malfunction, but is **an indication of the outstanding heat insulation** and the functionality of the insulating glass that is used.



The following generally applies to any insulating glass:

The lower the heat transmission (the smaller the U_g value or also: the better the insulating glass) the warmer the glass remains at the room side and therefore the colder the outside glass, which may become fogged.

Because of the improved insulation of triple-glazed units, condensation is more likely to form on the surface of the outer glass layer more frequently than with double-glazed units.

Internal condensation

The formation of dew on the room-side pane of glass is assisted if the air circulation is blocked (protruding soffits, curtains, unfavourable radiator arrangement, lack of ventilation) and the ambient air is too humid.

The ambient humidity must be adapted to the situation accordingly (dehumidifier, convector).

User Manual

Manually operated sliding doors

Sky-Frame partner: